

INSTALLATION INSTRUCTION

LDX-D50

Active ORing Controller



- MAIN FEATURES**
- Ultra-Compact Redundancy Module
 - CPU controlled
 - Wide input voltage range 12 – 85 VDC (on a single model)
 - 50 A Max
 - Extremely low loss up to 99% efficiency
 - Pluggable connectors
 - Hot pluggable
 - Easy acknowledgment of the power supplies availability status
 - Easy correct current share status
 - Up to 75°C operating temperature with no derating

READ THIS CAREFULLY BEFORE INSTALLATION!	VOR DER INSTALLATION BITTE FOLGENDE SICHERHEITSHINWEISE BEACHTEN!	LEGGERE ATTENTAMENTE PRIMA DELL'INSTALLAZIONE!	A LIRE ATTENTIVEMENT AVANT L'INSTALLATION!
<p>Before operating, read this document thoroughly and retain it for future reference. Non-respect of these instructions may reduce performances and safety of the devices and cause danger for people and property. The products must be installed, operated, serviced and maintained by qualified personnel in compliance with applicable standards and regulations. Do not open the device, it does not contain replaceable components, the tripping of the internal fuse (if included) is caused by an internal failure. Do not repair or modify the device, if malfunction or failure should occur during operation, send unit to the factory for inspection. No responsibility is assumed by Bel for any consequences deriving from the use of this material.</p>	<p>Lesen Sie dieses Dokument vor der Inbetriebnahme sorgfältig durch und bewahren Sie es zum späteren Nachschlagen auf. Die Nichtbeachtung dieser Anweisungen kann die Funktion und Sicherheit der Geräte beeinträchtigen und birgt Gefahren für Personen und Eigentum. Die Geräte müssen von qualifiziertem Personal unter Einhaltung der geltenden Normen und Vorschriften installiert, betrieben, gewartet und instand gehalten werden. Öffnen Sie das Gerät nicht, es enthält keine austauschbaren Komponenten, das Auslösen der internen Sicherung (falls vorhanden) ist stets auf tiefergehende Fehler im Schaltkreis zurück zu führen. Reparieren oder modifizieren Sie das Gerät nicht. Sollte während des Betriebs eine Fehlfunktion oder ein Defekt auftreten, schicken Sie das Gerät zur Überprüfung ins Werk. Bel übernimmt keine Haftung für die Folgen, die sich aus dem Einsatz dieses Gerätes ergeben.</p>	<p>Prima dell'installazione, leggere attentamente questo documento istruzioni e conservarle per future consultazioni. L'inosservanza delle presenti istruzioni può compromettere le caratteristiche e la sicurezza dell'apparecchio e causare pericolo per le persone e le cose. Il prodotto deve essere installato, utilizzato e riparato da personale qualificato e nel rispetto delle normative vigenti. Non aprire il prodotto, esso non contiene componenti sostituibili, il guasto del fusibile interno (se previsto) è causato da un guasto interno. Non tentare di riparare o modificare il prodotto, se durante il funzionamento si verificano guasti o anomalie, inviarlo al produttore per il controllo. Bel non si assume nessuna responsabilità per qualunque conseguenza derivante dall'uso di questo materiale.</p>	<p>Lire ces instructions avant l'installation, conserver ce manuel pour référence future. Défaut de se conformer à ces instructions peut affecter les caractéristiques et la sécurité du dispositif, et causer du danger aux personnes ou aux biens. Les produits doivent être installés, exploités et entretenus par du personnel qualifié et en conformité avec les règlements. N'ouvrez pas le produit, il ne contient aucune pièce réparable, le déclenchement du fusible interne (le cas échéant) est causé par un défaut interne. Ne pas essayer de réparer ou modifier le produit ; si des défaillances se produisent pendant le fonctionnement, retourner le produit au fabricant pour inspection. Bel n'assume aucune responsabilité des conséquences éventuelles découlant de l'utilisation des produits.</p>
CAUTION	ACHTUNG	ATTENZIONE	AVERTISSEMENT
<p>RISK OF BURNS, EXPLOSION, FIRE, ELECTRICAL SHOCK, PERSONAL INJURY. Never carry out work on live parts! Danger of fatal injury! The product's enclosure may be hot, allow time for cooling product before touching it. Do not allow liquids or foreign objects to enter into the products. To avoid sparks, do not connect or disconnect the device before having previously turned-off input power and wait for internal capacitors discharge (minimum 1 minute).</p>	<p>GEFAHR VON VERBRENNUNGEN, EXPLOSIONEN, FEUER, STROMSCHLAG, PERSONENSCHÄDEN. Führen Sie niemals Arbeiten an spannungsführenden Teilen durch! Gefahr von tödlichen Verletzungen! Das Gehäuse des Gerätes kann heiß sein, lassen Sie Zeit zum Abkühlen des Gerätes, bevor Sie es berühren. Lassen Sie keine Flüssigkeiten oder Fremdkörper in die Geräte eindringen. Um Überschläge zu vermeiden, schließen Sie das Gerät nicht an oder trennen Sie es nicht ohne vorher die Eingangsspannung abgeschaltet zu haben, und warten Sie die Entladung der internen Kondensatoren ab (mindestens 1 Minute).</p>	<p>RISCHIO USTIONI, ESPLOSIONE, INCENDIO, SCOSSA, LESIONI GRAVI. Non effettuare mai operazioni sulle parti sotto tensione! Pericolo di lesioni letali! Il contenitore può scottare, lasciar quindi raffreddare il dispositivo prima di toccarlo. Non far entrare liquidi o oggetti estranei nel dispositivo. Per evitare scintille, non collegare o scollegare l'apparecchiatura prima di avere tolto tensione di ingresso e prima che sia avvenuta la scarica dei condensatori interni (min. 1 minuto).</p>	<p>RISQUE DE BRULURES, EXPLOSION, INCENDIE, ELECTROCUTION, DOMMAGE AUX PERSONNES. Ne jamais effectuer des opérations sur les parties sous tension! Danger de mort! Le boîtier peut produire des brûlures, le laisser refroidir avant de toucher l'appareil. Ne faire pas pénétrer des liquides ou des corps étrangers dans l'appareil. Pour éviter des étincelles, ne pas connecter ou déconnecter l'équipement jusqu'à ce que la tension d'entrée a été supprimée et avant qu'il n'ait eut lieu la décharge des condensateurs internes (minimum 1 minute).</p>
INTENDED USE	BESTIMMUNGSGEMÄßER BETRIEB	USO PREVISTO	UTILISATION
<p>These are isolated devices suitable for SELV and PELV circuitry and are designed to be mounted on DIN rail and installed inside a protective enclosure. They are intended for general use such as in industrial control, communication, and instrumentation equipment. Do not use these devices in applications where malfunction may cause injury or death.</p>	<p>Es handelt sich um galvanisch getrennte Geräte, die für SELV- und PELV-Anwendungen geeignet sind und für die Montage auf DIN-Schienen und die Installation in einem Schutzgehäuse konzipiert sind. Sie sind für den allgemeinen Gebrauch wie z.B. in industriellen Steuer-, Kommunikations- und Automatisierung-Anwendungen vorgesehen. Verwenden Sie diese Geräte nicht in Anwendungen, bei denen eine Fehlfunktion zu Verletzungen oder zum Tod führen kann.</p>	<p>I dispositivi sono isolati, adatti per applicazioni SELV e PELV, sono dotati di aggancio per il montaggio su guida DIN all'interno di quadri elettrici o contenitori di protezione, per l'utilizzo con controllori industriali, unità di comunicazione o apparecchi di misura. Non utilizzare in applicazioni in cui un eventuale guasto può comportare rischio di lesioni o di morte.</p>	<p>Les produits sont isolés, appropriés pour les circuits TBTS et TBTP et sont équipés d'un crochet pour montage sur rail DIN dans des armoires ou conteneurs de protection, pour utilisation avec les contrôleurs industriels, des modules de communication ou des unités de mesure. Ne pas utiliser ces dispositifs dans une application où un dysfonctionnement pourrait entraîner le risque des blessures ou de mort.</p>
ENVIRONMENTAL CHARACTERISTICS	UMGEBUNGSBEDINGUNGEN	CARATTERISTICHE AMBIENTALI	CARACTÉRISTIQUES ENVIRONNEMENTALES
<p>Installation in a Pollution Degree 2 environment. Do not use in wet area or subject to moisture. Carefully recycle the product and related batteries according to local regulations.</p>	<p>Installation in einer Umgebung mit Verschmutzungsgrad 2. Nicht in nassen Bereichen oder unter Feuchtigkeit verwenden. Das Gerät und die zugehörigen Batterien sind entsprechend den lokalen Vorschriften zu recyceln bzw. zu entsorgen.</p>	<p>Usare in ambienti con Grado di Inquinamento 2. Non far funzionare l'apparecchio in un ambiente umido o soggetto a formazione di condensa. Riciclare il prodotto e le batterie collegate, nel rispetto delle normative locali vigenti.</p>	<p>Utiliser les produits dans des environnements avec degré de pollution 2. Ne pas employer l'appareil dans un environnement humide ou soumis à la condensation. Recycler les produits et les batteries, conformément à la réglementation locale.</p>

USER INSTRUCTIONS**1) DESCRIPTION**

DIN Rail Universal Active ORing Controller for redundant connection to a common Load of 2 DC Power supplies of same rating, with any voltage in the range 12 – 85 VDC and Load Current \leq 50 A.

Warning: Voltages \geq 60 VDC are dangerous! Use appropriate safety rules!

2) INSTALLATION

Use DIN-rails according to EN 60715. Installation should be made vertically (see Fig.4). For better device stability fix the rail to the wall close to the point where the device is to be mounted. In order to guarantee sufficient convection, we recommend observing a minimum distance to other modules (see Fig.3).

3) CONNECTIONS

The device is equipped with pluggable screw terminals. To avoid sparks, do not connect or disconnect the connectors before having previously turned-off input power and waited for internal capacitors discharge (minimum 1 minute)

In order to comply with UL certification, use appropriate copper cables of indicated cross section, designed for an operating temperatures of:

60°C for ambient up to 45°C

75°C for ambient up to 60°C

90°C for ambient up to 70°C

Strip the connecting ends of the wires according to the indication and ensure that all strands of a stranded wire enter the terminal connection (see Fig.5)

4) INPUT / OUTPUT CONNECTION

The device is suitable for SELV and PELV circuitry (if you use a source with V_{out} higher than 60 VDC it is not a SELV device)

Check V_{out} before connecting the power supply to the load.

5) OPERATION

Connect the LDX-D50 as indicated in Fig.7.

Turn on power supply "A" and adjust the load voltage to the needed level by measuring directly at the load.

Turn on power supply "B". Trim its voltage until the green LED in the LDX-D50 bar-graph is lit. At this moment power supplies "A" and "B" share the load with balanced currents.

In case one of the two power supplies does not operate anymore the load is supplied by the second one without any interruption.

6) STATUS SIGNALS

LDX-D50 provides specific status signals related to:

- acknowledgment of the power supplies availability (correct output voltage for each) (OR OK)
- correct current share between the two power supplies (SHARE OK)
- load current $>$ 50 A (OVERLOAD)

These signals are displayed on the LDX-D50 front panel trough LEDs and are also present on 2 relays dry contacts for remote monitoring of the unit.

IN1 (IN2) OK LED: Indicates that the voltage present on IN1 (IN2) is $>$ $0.9 \cdot V_{out}$. It is an indication of the presence of the correct voltage from the power supply connected to IN1 (IN2).

FAIL LED: Indicates that the system has a problem and the redundancy is no more guaranteed. It can have 3 status

- OFF continuously: means that the redundancy is guaranteed. In this status the OR-OK dry contact is closed
- ON continuously: means that the voltage on one of the two inputs is not present or out of range. In this status the OR-OK dry contact is open

Blinking at 0.5 Hz: means that the output current has exceeded the maximum of 50 A. In this status the SHARE-OK dry contact is closed and open at 0.5 Hz rate (1s ON / 1s OFF).

Current share bar-graph: Indicates the current distribution between the two power supplies. The current balancing is calculated in the following way: $unbal = (I_1 - I_2) / (I_1 + I_2)$; $bal = 0\%$ means perfect current sharing while $unbal = 100\%$ (-100%) indicates that the load current is provided only by power supply 1 (2).

The central green LED has a threshold of around $\pm 15\%$ current unbalancing, while the two external red LEDs are actives when the current unbalancing is greater than 60%.

When one of the two red LEDs is on the SHARE-OK dry contact is open.

Note: when the load current is $<$ 2 A the bar-graph green LED is always on and the SHARE-OK dry contact is always closed.

The current unbalancing is not calculated when the load current is $<$ 2 A.

OR-OK relay dry contact: It acts in exactly the same way as the FAIL LED. It is closed when the redundancy is guaranteed and open in case of failure.

The relay contact rating is 24 V / 1 A

SHARE-OK relay dry contact: It is closed when the load current unbalance is $<$ 60% and open when the current unbalance is $>$ 60% indicating that the current sharing between the two sources is lost. It toggles at 0.5 Hz rate (1s closed / 1s open) when the load current exceeds 50 A.



FIG.1 - CONNECTIONS	FIG.2 - DIMENSIONS	FIG.3 - DISTANCES																			
 <p>(1) Input PS1 50 A Max. (2) Input PS2 50 A Max. (3) Output Load 50 A Max. (4) Diagnostic Output: OR OK (dry contact, NC output OK) (5) Diagnostic Output: SHARE OK (dry contact, NC output OK) (6) Green LED: IN1 OK (7) Green LED: IN2 OK (8) Red LED: FAIL (9) Current share Bar-graph</p> <table border="0"> <tr> <td>Input DC Line:</td> <td>Output DC Line:</td> </tr> <tr> <td> <ul style="list-style-type: none"> IN1 += Positive DC IN1 -= Negative DC IN2 += Positive DC IN2 -= Negative DC </td> <td> <ul style="list-style-type: none"> OUT += Positive DC OUT- = Negative DC </td> </tr> </table>	Input DC Line:	Output DC Line:	<ul style="list-style-type: none"> IN1 += Positive DC IN1 -= Negative DC IN2 += Positive DC IN2 -= Negative DC 	<ul style="list-style-type: none"> OUT += Positive DC OUT- = Negative DC 	 <table border="1"> <thead> <tr> <th>Dimension</th> <th>mm (inc)</th> </tr> </thead> <tbody> <tr> <td>W</td> <td>40 (1.57)</td> </tr> <tr> <td>D</td> <td>110 (4.33)</td> </tr> <tr> <td>H</td> <td>115 (4.52)</td> </tr> </tbody> </table>	Dimension	mm (inc)	W	40 (1.57)	D	110 (4.33)	H	115 (4.52)	 <table border="1"> <thead> <tr> <th>Distance</th> <th>mm (inc)</th> </tr> </thead> <tbody> <tr> <td>A</td> <td>20 (0.8)</td> </tr> <tr> <td>B</td> <td>20 (0.8)</td> </tr> </tbody> </table>		Distance	mm (inc)	A	20 (0.8)	B	20 (0.8)
Input DC Line:	Output DC Line:																				
<ul style="list-style-type: none"> IN1 += Positive DC IN1 -= Negative DC IN2 += Positive DC IN2 -= Negative DC 	<ul style="list-style-type: none"> OUT += Positive DC OUT- = Negative DC 																				
Dimension	mm (inc)																				
W	40 (1.57)																				
D	110 (4.33)																				
H	115 (4.52)																				
Distance	mm (inc)																				
A	20 (0.8)																				
B	20 (0.8)																				

FIG.4 - MOUNTING / DISMOUNTING INSTRUCTIONS

For DIN rail fastening according to IEC 60715 TH35-7.5(-15)
 Mounting as shown in figure, with input terminals on lower side, with suitable cooling and maintaining a proper distance between adjacent devices as specified in the Installation Instruction of each family.

MOUNTING:

1. Tilt the unit slightly backwards.
2. Fit the unit over the top edge of the rail.
3. Slide it downward until it hits the stop.
4. Press against the bottom for locking.

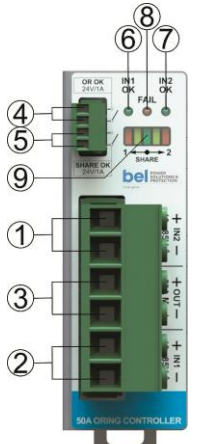
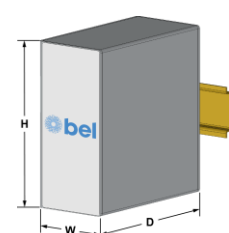
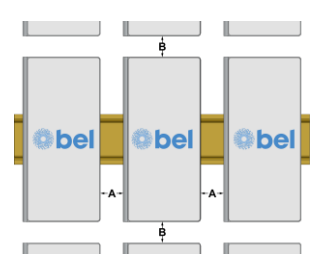
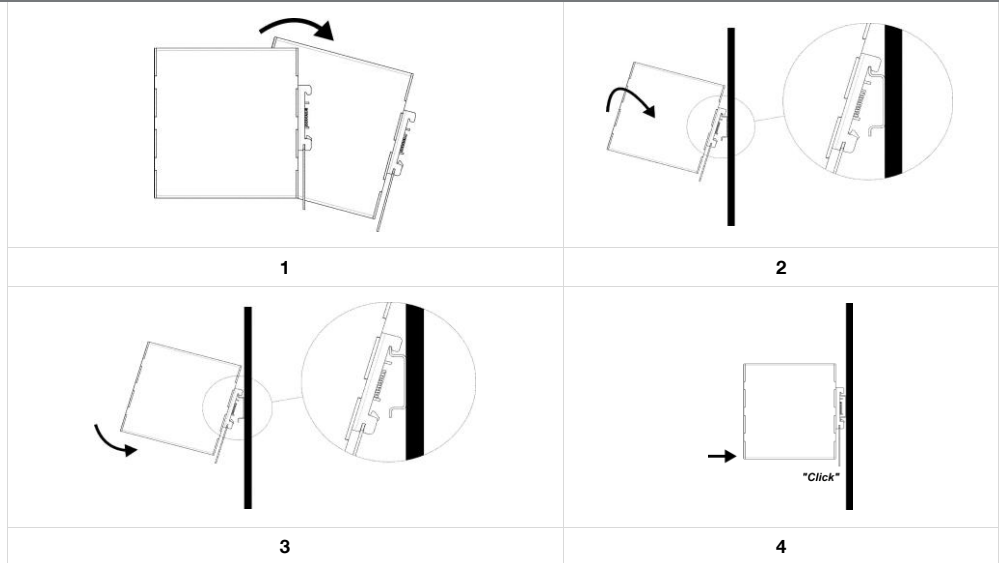

DISMOUNTING:

1. Pull down the slide clamp lever
2. Tilt the unit upward
Unhook the unit from the rail

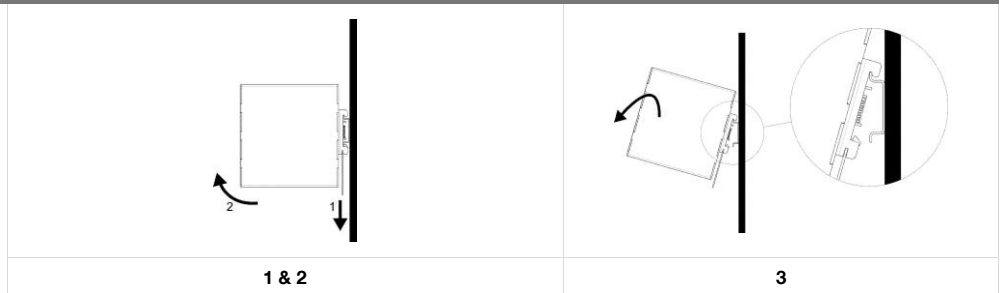

Manufacturer
 Bel Fuse Inc.
 300 Executive Drive, Suite 300
 West Orange, NJ 07052
 USA

Asia-Pacific
 +86 755 2988 5888

Europe, Middle East
 +353 61 49 8941

North America
 +1 866 513 2839

belfuse.com/power-solutions

© 2023 Bel Fuse Inc. BCM.00436_AE

FIG.5 - RECOMMENDED CONNECTING CABLE

	<p>Recommended Tightening torque 1.2 Nm 10.4 lbf in</p>		<p>Input / Output Solid: 0.75 - 16 mm² / 18 - 6 AWG Stranded: 0.75 - 16 mm² / 18 - 6 AWG L: 13 - 14 mm / 0.51 - 0.55 in</p> <p>Signals Solid: 0.05 - 1.5 mm² / 30 - 14 AWG Stranded: 0.0 - 1.5 mm² / 30 - 14 AWG L: 5 - 6 mm / 0.20 - 0.24 in</p>
---	--	--	---

FIG.6 - INPUT PROTECTION

The Device is provided in input against the Reverse polarity connection.

FIG.7 – SET-UP

INPUT / OUTPUT CONNECTION

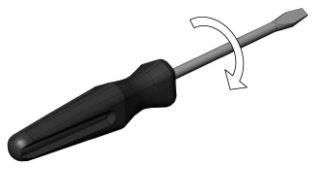
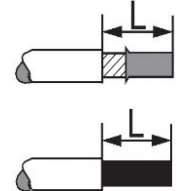
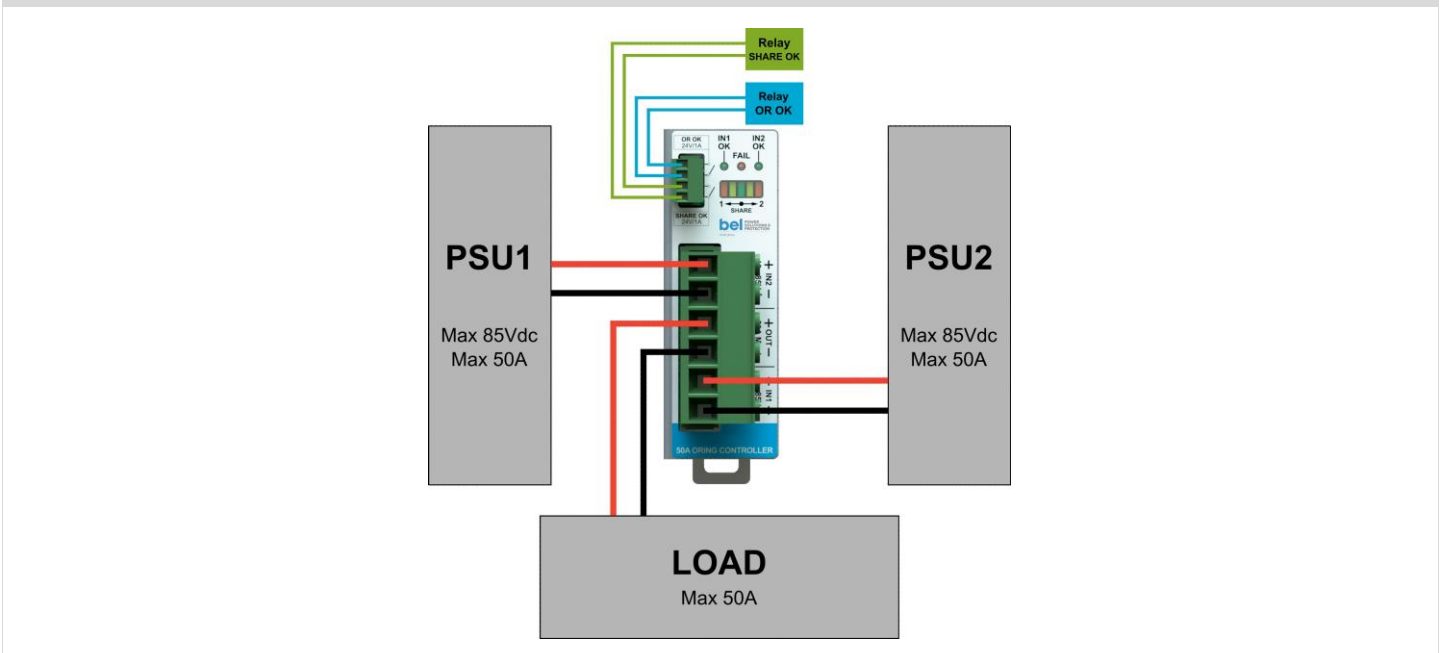

FIG.8 - ENVIRONMENT

OPERATING TEMPERATURE	DERATING
- 40°C to + 75°C 5 - 95% r.H. non condensing UL Certified up to 75°C	No derating

NOTES:

- Data may change without prior notice in order to improve the product.
- Please refer to the latest version of [LDX-D50 Datasheet](#) or [LDX-D50 Installation Instruction](#) on our website: belfuse.com/power-solutions



Manufacturer
Bel Fuse Inc.
300 Executive Drive, Suite 300
West Orange, NJ 07052
USA

Asia-Pacific
+86 755 2988 5888

Europe, Middle East
+353 61 49 8941

North America
+1 866 513 2839

belfuse.com/power-solutions

© 2023 Bel Fuse Inc. BCM.00436_AE