

Expanded Beam Connectors for Outdoor Broadcast

The Fibreco S-Lite™ Expanded Beam connector is designed as a cost effective, high performance and reliable expanded beam solution for use in the outdoor broadcast industry, as well as other rugged and harsh environments. Although it can be used in some military applications, as it is based on the M83526 expanded beam connector, it is designed to specifically target the outdoor broadcast market. The S-Lite connectors versatility, also includes a hybrid version, combining electrical with optical to target SMPTE cable specific programs.

The connectors are terminated using an epoxy-polish ferrule termination process with standard fiber optic termination tools and equipment. The terminated ferrules are simply inserted into the expanded beam housing and fixed in place via a spring and cover-plate. Ferrule alignment to the lenses is achieved automatically by the unique optical arrangement developed and patented by Fibreco®.

All of the S-Lite™ expanded beam connector series offer high performance, flexibility and cost effectiveness, combined with a simple termination process allowing rapid in-field termination and repair.

Features

- Singlemode and Multimode Options
- Field terminable using standard termination tools & equipment
- Field repairable: EB insert & shell parts replaceable / re-useable
- Hybrid contains 2 fiber, 2-16AWG contacts, 2-20AWG contacts
- Lightweight and cost effective
- XLR Bulkhead design for easy “drop-in” replacement
- Bulkhead sealing option available



Insertion Loss	Singlemode: -1.5dB maximum (typical -1.0dB)* Multimode: -1.0dB maximum (typical -0.7dB)*
Return Loss	> 32dB (typical 40dB) Singlemode / >20dB Multimode*
Electrical Power Contacts	Size 20 & size 16, MIL-C-39029 Contact resistance <4mΩ Operating voltage 1000VAC Operating current 5A (short term 15A)
Electrical Test Voltage	Between contacts and contact / housing: 3000V / 50 Hz, 1 minute EN61984
Durability	500 Matings minimum
High Temperature Storage	+75°C
Low Temperature Storage	-40°C
IP Rating	IP65
Free Fall Resistance	5 Falls from 1.2m height
Vibration	10-55Hz, 3 directions, 1.52mm amplitude @ 20g acceleration
Flexing	5000 cycles at 20N**
Cable Retention	200N (cable dependant)
Weight (approx)	90g
Connector Shell Material/Color	Shell: Black Valox 420SEO; Insert Arcap AP1D
Thermal Shock	-55°C to 85°C

*Measurements against reference—random mate performance in line with MIL-DTL-83526

Connector Ordering Information

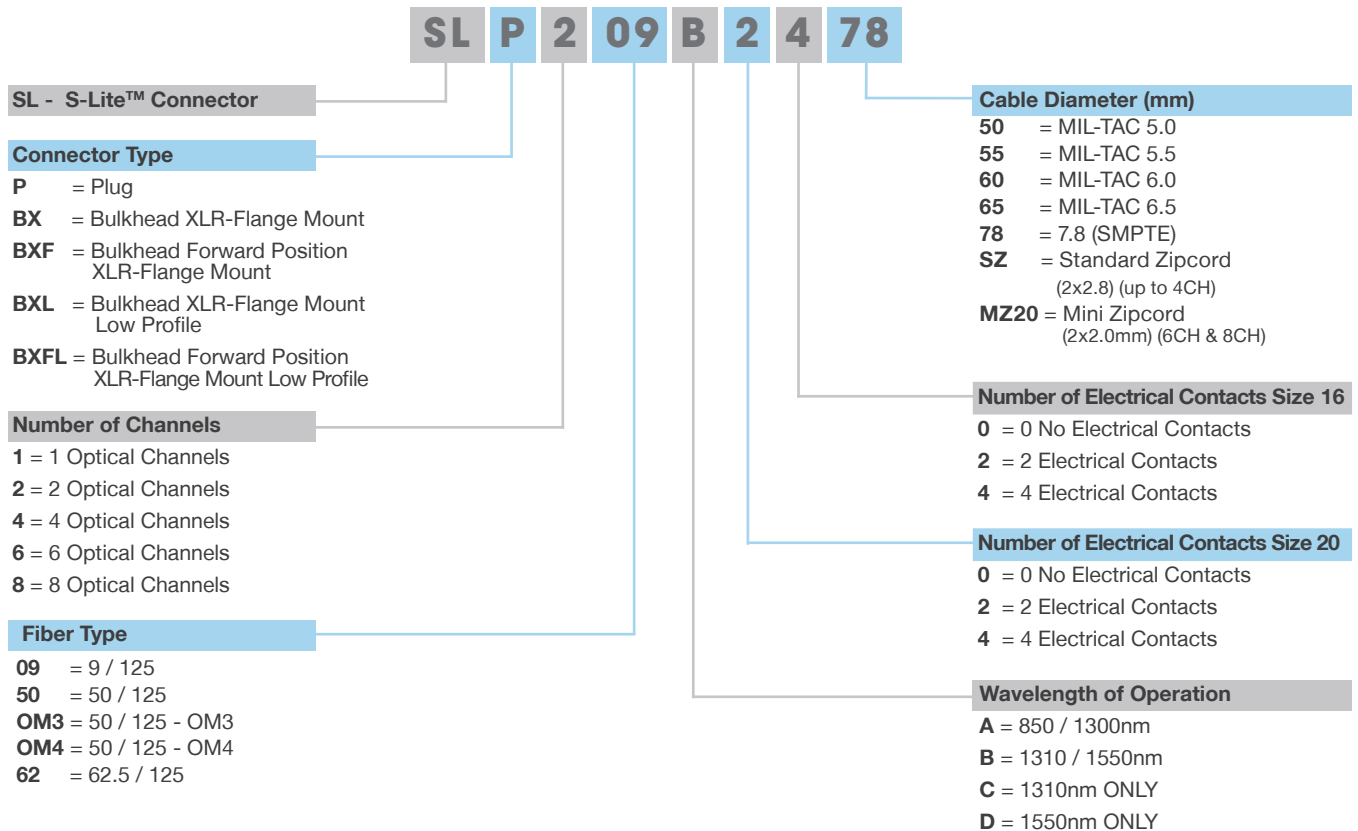

Optical Insert Arrangement

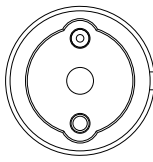

1416 - 1CH OPTICAL

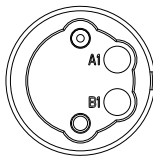

1423 - 2CH OPTICAL

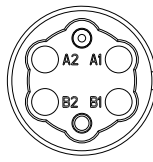

1540 - 4CH OPTICAL

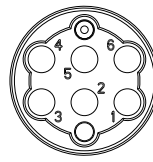

1490 - 6CH OPTICAL

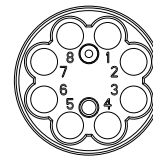

2042 - 8CH OPTICAL

Hybrid Insert Arrangement

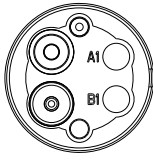

14621 - 2CH OPTICAL
2 POWER (#16)

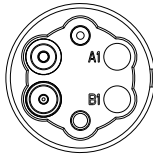

1594 - 2CH OPTICAL
2 SIGNAL (#20)

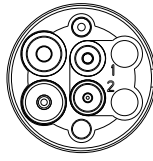

1432 - 2CH OPTICAL
2 POWER (#16)
2 SIGNAL (#20)

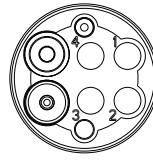

1519 - 4CH OPTICAL
2 POWER (#16)

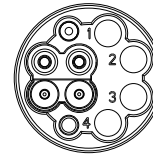

1596 - 4CH OPTICAL
4 ELECTRICAL (#20)

Bulkhead Cutout

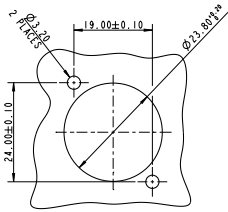

Bulkhead with Strain Relief Connector

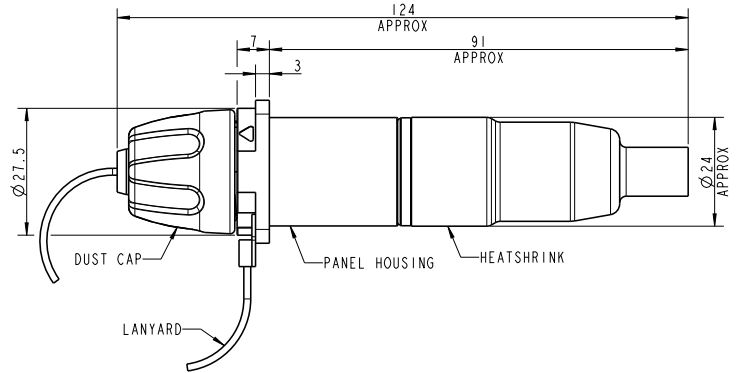

Bulkhead Connector

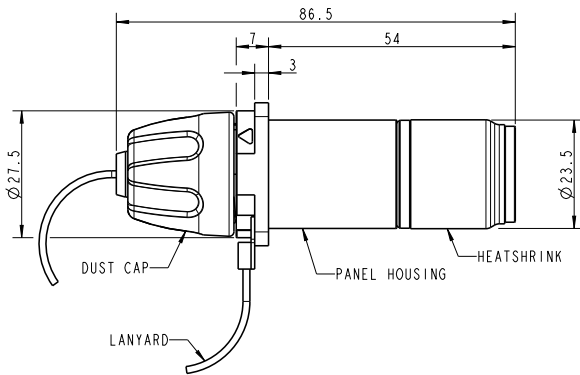

Plug Connector

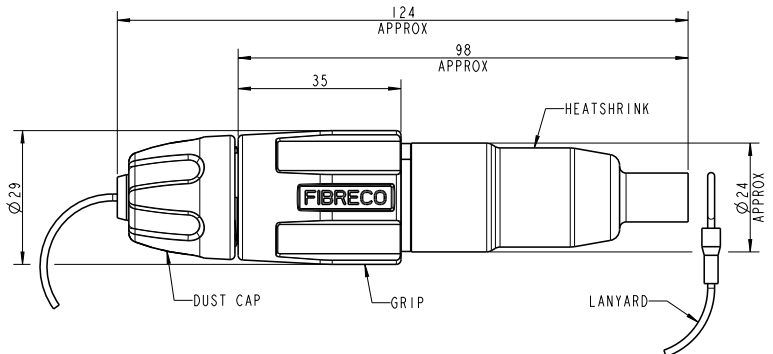

Asia Pacific
+86 21 5442 7668
ccs.asia.sales@as.cinch.com

Europe, Middle East & Africa
+44 (0) 1245 342060
CinchConnectivity@eu.cinch.com

North America
+1 507.833.8822
ccsorders@us.cinch.com

belfuse.com/cinch